





A4				 台普 ROCPCU	COMMON TOLERANCE X.XX ± 0.10 X.X ± 0.15 X ± 0.25 ANGULAR —	UNIT	MM	PROJECTED		PRODUCT NAME:	
A3			DRAWN BY			SHUHAO	CHECKED BY	COCO	MODEL NO: TP91644G□□□□		
A2			DATE			2019	APPROVAL B	ALEN	Https: www.rocpcu.tw		
A1			ROCPCU TECHNOLOGY CO.,LTD								
REV	DATE	REVISION	DESCRIPTION			ISSUE	Copies are issued in strict confidence and shall not be reproduced or copied, or used as the basis of manufacture or sale of apparatus without permission				



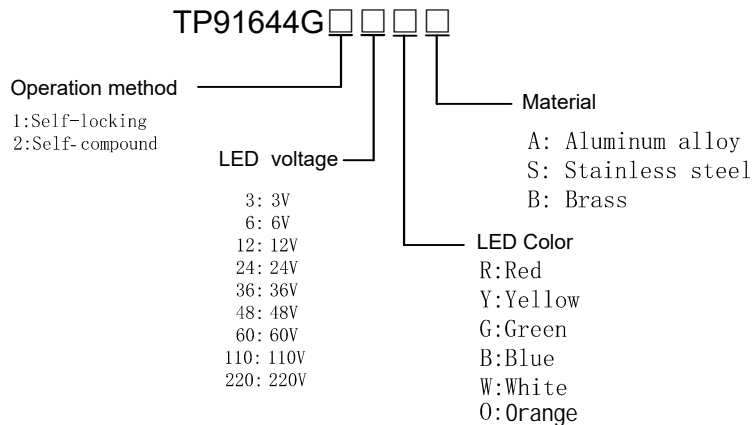

性能参数

1. Heating current: Ui: AC250V, Ith: 3A
发热电流: Ui: AC250V, Ith: 3A
2. Rated current: 2A/DC36V
额定电流: 2A/DC36V
3. Power-frequency withstand voltage: 2000V1min
工频耐压: 2000V1min
4. Insulation resistance: ≥1000MΩ
绝缘电阻: ≥1000MΩ
5. Contact resistance: ≤50mΩ
接触电阻: ≤50mΩ
6. Pressing stroke: 2.80mm ± 0.10
按压行程: 2.80mm ± 0.10
7. Contact stroke: 1.10mm ± 0.10
接触行程: 1.10mm ± 0.10
8. Nut assembly torque: 5-14N
螺帽装配力矩: 5-14N
9. Protection level: IP67

- 防护等级: IP67
10. Explosion prevention level: IK09
防暴等级: IK09
 11. Working environment temperature: -20 °C ~ +55 °C
工作环境温度: -20 °C ~ +55 °C
 12. Compression torque: ≤ 3N
按压扭力: ≤ 3N
 13. Electrical life: 500000 cycles
电气寿命: 500000 cycles
 14. mechanical: 500000 cycles
机械寿命: 500000 cycles
 15. NO reverse thrust foot torque: ≤ 30N
NO反推脚扭力: ≤ 30N
 16. LED lamp power consumption: 20m以下
LED灯功耗: 20m以下
 17. LED lamp lifespan: 40000h
LED寿命: 40000h

A4				 台普 ROCPCU	COMMON TOLERANCE		UNIT	MM	PROJECTED		PRODUCT NAME:
A3					X.XX	± 0.10	DRAWN BY	SHUHAO	CHECKED BY	COCO	MODEL NO: TP91644G □ □ □ □
A2					X.X	± 0.15	DATE	2019	APPROVAL B	ALEN	Https: www.rocpu.tw
A1					X	± 0.25	ROCPCU TECHNOLOGY CO., LTD				
REV	DATE	REVISION	DESCRIPTION		ISSUE	ANGULAR					
	A		B		C		D	E	F	G	

NO 序号	Part name 部件名	Material 材料	QTY 数量	Remark 备注
1	Key 按键	SUS/Aluminum alloy/Brass 不锈钢/铝合金/黄铜	1	
2	Housing 外壳	SUS/Aluminum alloy/Brass 不锈钢/铝合金/黄铜	1	
3	Oring O型圈	Silica gel 硅胶	1	
4	Arm nut 固定螺帽	Brass 黄铜	1	nickeling 镀镍
5	Base 基座	PA66	1	Black 黑色
6	Contact material 接触材质	Silvering 镀银	1	
7	Pin 引脚	Brass 黄铜	1	gold-plating 镀金
8	LEDpin LED脚	Brass 黄铜	1	Silvering 镀银
9	luminous zone 发光区	PC 塑料	1	

A4				 台普 ROCPCU	COMMON TOLERANCE		UNIT	MM	PROJECTED		PRODUCT NAME:
A3					X.XX	± 0.10	DRAWN BY	SHUHAO	CHECKED BY	COCO	MODEL NO: TP91644G□□□□
A2					X.X	± 0.15	DATE	2019	APPROVAL B	ALEN	Https: www.rocpu.tw
A1					X	± 0.25	ROCPCU TECHNOLOGY CO.,LTD				
REV	DATE	REVISION	DESCRIPTION		ISSUE	ANGULAR					