

Schematic Diagram
电气原理图

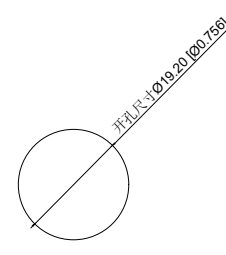

Installation View
安装视图

A4				
A3				
A2				
A1				
REV	DATE	REVISION	DESCRIPTION	ISSUE

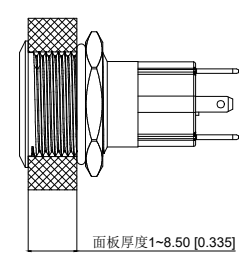
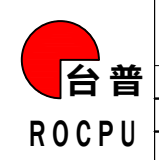

COMMON TOLERANCE	
X.XX	± 0.10
X.X	± 0.15
X	± 0.25
ANGULAR	—

UNIT	MM	PROJECTED		PRODUCT NAME:
DRAWN BY	SHUHAO	CHECKED BY	COCO	MODEL NO: TP991901P□□□□
DATE	2019	APPROVAL B	ALEN	Https: www.rocpcu.tw
ROCPCU TECHNOLOGY CO., LTD				
Copies are issued in strict confidence and shall not be reproduced or copied, or used as the basis of manufacture or sale of apparatus without permission				

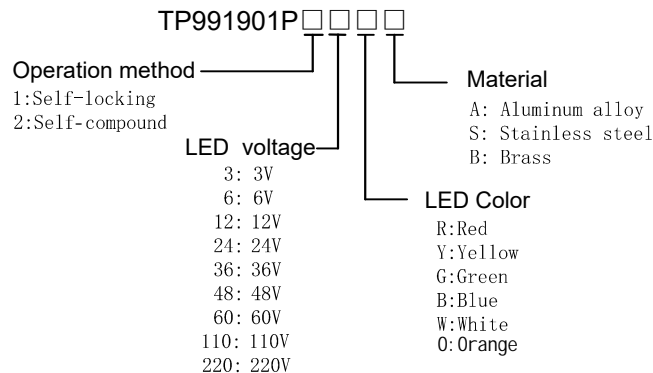

连接形式



- Welding temperature of wire: 320 ± 20 °C
线材焊接温度: 320±20°C
Wire welding duration: less than 3 seconds
线材焊接时长: 时长3秒以下
- Can be used with dedicated connectors:
可配专用接插件使用:
 - Switch function wire: Blue wire (NO) (1.0²mm)
开关功能线材: 蓝线 (NO) (1.0²mm)
 - LED functional wire: red wire positive pole black wire negative pole(0.5²mm)
LED功能线材: 红线正极 黑线负极(0.5²mm)
 - LED is an electrodeless lamp bead that can be lit without the need to separate positive and negative poles
LED为无极灯珠, 无需分正负极也可点亮

性能参数



- Heating current: Ui: AC250V, Ith: 10A
发热电流: Ui: AC250V, Ith: 10A
- Rated current:10A,AC110V/220V
10A,DC12V/24V
额定电流:10A,AC110V/220V
10A,DC12V/24V
- Power-frequency withstand voltage:1500V/1min
工频耐压:1500V/1min
- Insulation resistance:≥1000MΩ
绝缘电阻 :≥1000MΩ
- Contact resistance:≤50mΩ
接触电阻 :≤50mΩ
- Pressing stroke:4.00mm ± 0.10
按压行程:4.00mm ± 0.10
- Contact stroke:1.20mm±0.10
接触行程 :1.20mm±0.10
- welding temperature: 320 °C± 20 °C
焊接温度: 320 °C± 20 °C
- Welding duration: Less than 3 seconds in duration
焊接时长: Less than 3 seconds in duration
- Nut assembly torque:5-14N.m

螺帽装配力矩:5-14N.m

- Protection level:IP67
防护等级:IP67
- Explosion prevention level: IK10
防暴等级: IK10
- Working environment temperature: -40 °C~+80 °C
工作环境温度: -40 °C~+80 °C
- Compression torque: ≤ 5.0N
按压扭力: ≤5.0N
- Electrical life: 50,000 cycles
电气寿命: 50,000 cycles
- Mechanical: 500,000cycles
机械寿命: 500,000cycles
- LED lamp power consumption: 20mA以下
LED灯功耗: 20mA以下
- LED lamp lifespan: 40000h
LED寿命: 40000h
- NO reverse thrust foot torque: ≤30N
NO反推脚扭力: ≤30N

A4					COMMON TOLERANCE		UNIT	MM	PROJECTED		PRODUCT NAME:
A3					X.XX	± 0.10	DRAWN BY	SHUHAO	CHECKED BY	COCO	MODEL NO:TP991901P□□□□
A2					X.X	± 0.15	DATE	2019	APPROVAL B	ALEN	Https: www.rocpcu.tw
A1					X	± 0.25	<h1>ROCPCU TECHNOLOGY CO.,LTD</h1>				
REV	DATE	REVISION	DESCRIPTION		ISSUE	ANGULAR					
	A		B		C		D	E	F	G	

NO 序号	Part name 部件名	Material 材料	QTY 数量	Remark 备注
1	Key 按键	SUS/Aluminum alloy/Brass 不锈钢/铝合金/黄铜	1	
2	Housing 外壳	SUS/Aluminum alloy/Brass 不锈钢/铝合金/黄铜	1	
3	Oring O型圈	Silica gel 硅胶	1	
4	Arm nut 固定螺帽	Brass 黄铜	1	nickeling 镀镍
5	Contact material 接触材质	silver alloy 银合金	1	
6	NOPin NO引脚	Brass 黄铜	1	gold-plating 镀金
7	Base 底座	PBT	1	
8	LEDpin LED引脚	Brass 黄铜	1	Silvering 镀银
9	luminous zone 发光区	PC 塑胶	1	

A4				 台普 ROCPCU	COMMON TOLERANCE		UNIT	MM	PROJECTED		PRODUCT NAME:
A3					X.XX	± 0.10	DRAWN BY	SHUHAO	CHECKED BY	COCO	MODEL NO:TP991901P□□□□
A2					X.X	± 0.15	DATE	2019	APPROVAL B	ALEN	Https: www.rocpu.tw
A1					X	± 0.25	ROCPCU TECHNOLOGY CO.,LTD				
REV	DATE	REVISION	DESCRIPTION		ISSUE	ANGULAR					