



A4				 <b>台普</b> <b>ROCPCU</b>	COMMON TOLERANCE		UNIT	MM	PROJECTED		PRODUCT NAME:
A3					X.XX	± 0.10	DRAWN BY	SHUHAO	CHECKED BY	COCO	MODEL NO: TP92210P <input type="checkbox"/> <input type="checkbox"/> <input type="checkbox"/> <input type="checkbox"/>
A2					X.X	± 0.15	DATE	2019	APPROVAL B	ALEN	Https: <a href="https://www.rocpcu.tw">www.rocpcu.tw</a>
A1					X	± 0.25	<h1>ROCPCU TECHNOLOGY CO.,LTD</h1>				
REV	DATE	REVISION	DESCRIPTION		ISSUE	ANGULAR					
A		B		C		D		E		F	



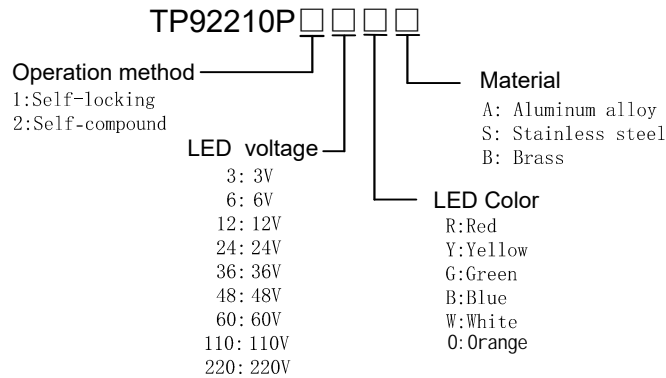

**连接形式**

- Welding temperature of wire: 320 ± 20 °C  
 线材焊接温度: 320±20°C  
 Wire welding duration: less than 3 seconds  
 线材焊接时长: 时长3秒以下
- Can be used with dedicated connectors:  
 可配专用接插件使用:
  - Switch function wire: green (C) blue wire (NO) yellow wire (NC)  
 开关功能线材: 绿色(C) 蓝线 (NO) 黄线 (NC)
  - LED functional wire: red wire positive pole black wire negative pole  
 LED without distinguishing positive and negative poles  
 LED功能线材: 红线正极 黑线负极 LED不分正负极



**性能参数**

- Heating current: Ui: AC250V, Ith: 5A  
 发热电流: Ui: AC250V, Ith: 5A
- Rated current:3A/DC36V  
 额定电流:3A/DC36V
- Power-frequency withstand voltage:2000V1min  
 工频耐压:2000V1min
- Insulation resistance:≥1000MΩ  
 绝缘电阻 :≥1000MΩ
- Contact resistance:≤50mΩ  
 接触电阻 :≤50mΩ
- Pressing stroke:2.50mm ± 0.10  
 按压行程:2.50mm ± 0.10
- Contact stroke:1.50mm±0.10  
 接触行程 :1.50mm±0.10
- Nut assembly torque:5-14N  
 螺帽装配力矩:5-14N
- Protection level:IP67  
 防护等级:IP67

- Explosion prevention level: IK10  
 防暴等级: IK10
- Working environment temperature: -20 °C~+55 °C  
 工作环境温度: -20 °C~+55 °C
- Compression torque: ≤ 6N  
 按压扭力: ≤ 6N
- Electrical life: 100000 cycles  
 电气寿命: 100000 cycles
- mechanical: 500000cycles  
 机械寿命: 500000cycles
- LED lamp power consumption: 20m以下  
 LED灯功耗: 20m以下
- LED lamp lifespan: 40000h  
 LED寿命: 40000h
- NO reverse thrust foot torque: ≤30N  
 NO反推脚扭力: ≤30N

A4				 <b>台普</b> <b>ROCPCU</b>	COMMON TOLERANCE		UNIT	MM	PROJECTED		PRODUCT NAME:
A3					X.XX	± 0.10	DRAWN BY	SHUHAO	CHECKED BY	COCO	MODEL NO:TP92210P <input type="checkbox"/> <input type="checkbox"/> <input type="checkbox"/> <input type="checkbox"/>
A2					X.X	± 0.15	DATE	2019	APPROVAL B	ALEN	Https: www.rocpcu.tw
A1					X	± 0.25	ROCPCU TECHNOLOGY CO.,LTD				
REV	DATE	REVISION	DESCRIPTION		ISSUE	ANGULAR					
	A		B		C		D	E	F	G	

NO 序号	Part name 部件名	Material 材料	QTY 数量	Remark 备注
10	luminous zone 发光区	PC 塑胶	1	
9	LEDpin LED引脚	Brass 黄铜	1	Silvering 镀银
8	Base 底座	PA46	1	
7	Pin 引脚	Brass 黄铜	1	gold-plating 镀金
6	Contact material 接触材质	silver alloy 银合金	1	Silvering 镀银
5	LED Base LED基座	PC 塑胶	1	
4	Arm nut 固定螺帽	Brass 黄铜	1	nickeling 镀镍
3	Oring O型圈	Silica gel 硅胶	1	
2	Housing 外壳	SUS/Aluminum alloy/Brass 不锈钢/铝合金/黄铜	1	
1	Key 按键	SUS/Aluminum alloy/Brass 不锈钢/铝合金/黄铜	1	

A4				 <b>台普</b> <b>ROCPCU</b>	COMMON TOLERANCE		UNIT	MM	PROJECTED		PRODUCT NAME:
A3					X.XX	± 0.10	DRAWN BY	SHUHAO	CHECKED BY	COCO	MODEL NO:TP92210P□□□□
A2					X.X	± 0.15	DATE	2019	APPROVAL B	ALEN	Https: www.rocpcu.tw
A1					X	± 0.25	ROCPCU TECHNOLOGY CO.,LTD				
REV	DATE	REVISION	DESCRIPTION		ISSUE	ANGULAR					