



A4				 台普 ROCPCU	COMMON TOLERANCE X.XX ± 0.10 X.X ± 0.15 X ± 0.25 ANGULAR —	UNIT	MM	PROJECTED		PRODUCT NAME:	
A3							DRAWN BY	SHUHAO	CHECKED BY	COCO	MODEL NO: TP92217P□□□□
A2							DATE	2019	APPROVAL B	ALEN	Https: www.rocpcu.tw
A1							ROCPCU TECHNOLOGY CO.,LTD				
REV	DATE	REVISION	DESCRIPTION			ISSUE	Copies are issued in strict confidence and shall not be reproduced or copied, or used as the basic of manufacture or sale of apparatus without permission				



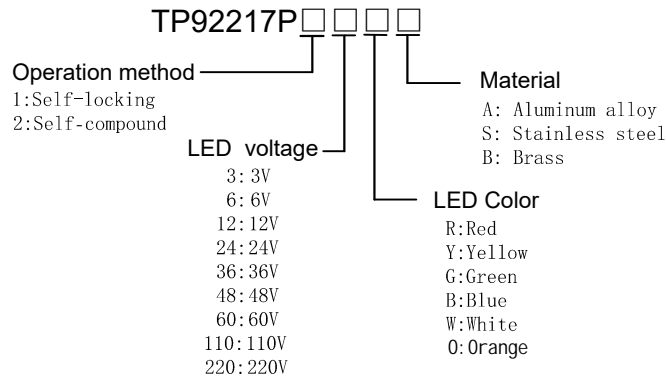

连接形式

- Welding temperature of wire: 320 ± 20 °C
 线材焊接温度: 320 ± 20 °C
 Wire welding duration: less than 3 seconds
 线材焊接时长: 时长3秒以下
- Can be used with dedicated connectors:
 可配专用接插件使用:
 - Switch function wire: green (C) blue wire (NO) yellow wire (NC)
 开关功能线材: 绿色(C) 蓝线(NO) 黄线(NC)
 - LED functional wire: red wire positive pole black wire negative pole
 LED without distinguishing positive and negative poles
 LED功能线材: 红线正极 黑线负极 LED不分正负极



性能参数

- Heating current: U_i : AC250V, I_{th} : 5A
 发热电流: U_i : AC250V, I_{th} : 5A
- Rated current: 3A/DC36V
 额定电流: 3A/DC36V
- Power-frequency withstand voltage: 2000V1min
 工频耐压: 2000V1min
- Insulation resistance: $\geq 1000M\Omega$
 绝缘电阻: $\geq 1000M\Omega$
- Contact resistance: $\leq 50m\Omega$
 接触电阻: $\leq 50m\Omega$
- Pressing stroke: $2.50mm \pm 0.10$
 按压行程: $2.50mm \pm 0.10$
- Contact stroke: $1.50mm \pm 0.10$
 接触行程: $1.50mm \pm 0.10$
- Nut assembly torque: 5-14N
 螺帽装配力矩: 5-14N
- Protection level: IP67
 防护等级: IP67

- Explosion prevention level: IK10
 防暴等级: IK10
- Working environment temperature: -20 °C ~ $+55$ °C
 工作环境温度: -20 °C ~ $+55$ °C
- Compression torque: $\leq 4N$
 按压扭力: $\leq 4N$
- Electrical life: 100000 cycles
 电气寿命: 100000 cycles
- mechanical: 500000 cycles
 机械寿命: 500000 cycles
- LED lamp power consumption: 20m以下
 LED灯功耗: 20m以下
- LED lamp lifespan: 40000h
 LED寿命: 40000h
- NO reverse thrust foot torque: $\leq 30N$
 NO反推脚扭力: $\leq 30N$

A4				 台普 ROCPCU	COMMON TOLERANCE		UNIT	MM	PROJECTED		PRODUCT NAME:
A3					X.XX	± 0.10	DRAWN BY	SHUHAO	CHECKED BY	COCO	MODEL NO: TP92217P□□□□
A2					X.X	± 0.15	DATE	2019	APPROVAL B	ALEN	Https: www.rocpcu.tw
A1					X	± 0.25	ROCPCU TECHNOLOGY CO.,LTD				
REV	DATE	REVISION	DESCRIPTION		ISSUE	ANGULAR					
	A		B		C		D	E	F	G	

NO 序号	Part name 部件名	Material 材料	QTY 数量	Remark 备注
10	luminous zone 发光区	PC 塑胶	1	
9	LEDpin LED引脚	Brass 黄铜	1	Silvering 镀银
8	Base 底座	PA46	1	
7	Pin 引脚	Brass 黄铜	1	gold-plating 镀金
6	Contact material 接触材质	silver alloy 银合金	1	Silvering 镀银
5	LED Base LED基座	PC 塑胶	1	
4	Arm nut 固定螺帽	Brass 黄铜	1	nickeling 镀镍
3	Oring O型圈	Silica gel 硅胶	1	
2	Housing 外壳	SUS/Aluminum alloy/Brass 不锈钢/铝合金/黄铜	1	
1	Key 按键	SUS/Aluminum alloy/Brass 不锈钢/铝合金/黄铜	1	

A4				 台普 ROCPCU	COMMON TOLERANCE		UNIT	MM	PROJECTED		PRODUCT NAME:
A3					X.XX	± 0.10	DRAWN BY	SHUHAO	CHECKED BY	COCO	MODEL NO:TP92217P□□□□
A2					X.X	± 0.15	DATE	2019	APPROVAL B	ALEN	Https: www.rocpcu.tw
A1					X	± 0.25	ROCPCU TECHNOLOGY CO.,LTD				
REV	DATE	REVISION	DESCRIPTION		ISSUE	ANGULAR					